



House Climate Control



⚠ WARNING!

It is recommended that you read the entire manual before proceeding with the installation.

⚠ WARNING!

In order to receive assistance on the product, the panel must be connected to the internet and be online.

Summary

I	WARNINGS	4
	Notes on the plant preparation for HCC	4
	Plant examples.	5
	Connecting to the Kita heat pump.	5
	System overview.....	6
	Sensore ROOM guide	6
	TM board.....	6
	I/O FLOOR board guide	8
II	Address Programming procedure, Temperature offset and Humidity offset for FW versions> 1.2	9
	Address Configuration.....	9
	Configuration Temperature offset and relative humidity offset	10
	Errors and Malfunctions.....	11
III	Modbus data network check.....	12
IV	First start	12
1	INTRODUCTION	13
1.1	HOW DOES IT WORK.....	13
1.2	Profiles	13
1.5	Menu bar overview.....	14
1.3	Mode.....	14
1.4	Changing setpoints via ROOM Sensors.....	14
2	ENVIROMENTS.....	15
2.1	Enviroments list	15
2.2	Enviroment.....	15
2.3	Setpoint change.....	15
2.4	Mixer	15
3	HEAT PUMP	16
3.1	Base	16
3.1.1	Overview	16
3.2	Heat pump settings.....	17
3.2.1	Climatic curve	17
3.2.2	Optimizer.....	18
4	SETTINGS.....	18
4.1	Base.....	18
4.1.1	Change language.....	19
4.1.2	Anti-legionella settings	19
4.2	Advanced.....	19
4.3	Builder.....	20
4.3.1	Room sensor settings	21
4.3.2	Set address	21
4.3.3	More	21
4.3.3.1	Square meters assignment.....	22
4.3.3.2	Service settings	23
4.3.4	Set password	23
4.4	Alarm.....	23
5	SCHEDULING.....	24
5.1	Scheduling	24
6	ADVANCED USE OF THE PANEL.....	24
6.1	Access advanced features of the HCC panel	24
6.2	Set a fixed IP address	25
6.3	Change the password for remote access.	25
6.4	Remote vision of the HCC panel	25

I WARNINGS

To be able to monitor the panel remotely using a VNC program, it is necessary that the house is equipped with internet access, and that the HCC Touch panel is physically connected via a network cable to the home router or switch.

The panel comes with the "Easy Access" function already activated, which lasts for the life of the panel. This function allows, using a specific client, to remotely access the panel using a PC or a Smartphone without further configuration, only by entering the user and password of the Easy Access account. Access credentials are provided by email to the customer at the time of activation. For this reason at the time of purchase it is necessary to provide a valid email address where you will receive all useful information.

Notes on the plant preparation for HCC

The HCC devices require power as follows:

panel	24Vdc	700mA
I/O FLOOR	24Vdc	1A
ROOM	24Vdc	200mA per sensor

Then prepare the power supply of adequate power to support the system, or use HCC POW.

MODBUS cable:	Templari HCC cable (similar Belden 3105A 2x22AWG shielded)
Power cable:	2x1 mmq
Power supply:	HCC POW 24Vdc, 2.5A

Prepare the electrical system for the passage of cable ducts by at least 16 mm in diameter for the passage of only MODBUS cable and power supply for sensors and devices.

Modbus connection

⚠ WARNING!

We recommend using the HCC CABLE data cable

The connections between the BMS board mounted on the machine and the different devices (Touch Panel HCC, HCC ROOM sensor, HCC FLOOR board) must comply with the connections shown in Tab1 and Figure 1.

The HCC system can also be connected to the PAn network of the µPC as shown in Figure 6.

Connect the G (Ground) pole of the HCC Connect cable of the Touch HCC Panel to the shield of the Modbus data network.

Connect the ground terminal of the power supply to the shield of the Modbus data network.

The shields of the various cable sections, between the various devices (HCC ROOM sensor and HCC FLOOR board), must be connected in series and NOT inserted in the G pole of each device, as in Figure2

BMS	Data cable	Touch Panel HCC	HCC FLOOR e ROOM sensors
GND	shielding socket	shielding socket	
+	A	A	A
-	B	B	B

Tab1

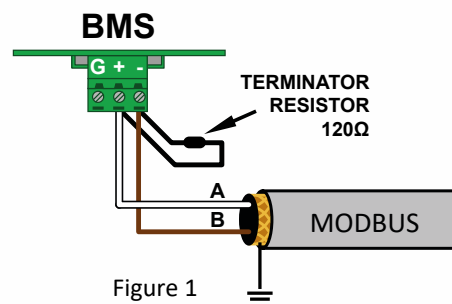

Figure 1

Installation Note: MODBUS data cabling should **not** ever be done with direct branches that form Y or stars.

The connection between a device and the next must take place via "concatenated" connections, connecting in sequence the sensors and MODBUS devices. It is therefore convenient to prepare the fitting of cables for the passage of 2 MODBUS data cables; the first intended for the device in question and the second will be the return to connect the next device.

Each cable duct which ends on a sensor will then have at its inner 3 wirings:

2 MODBUS cables (one that comes inside plus one going out), plus one power supply consists of 2 wires 2x1

An exception is the 2-terminal devices (usually, the heat pump and the HCC panel) which instead will have a single MODBUS cable and one power supply.

- For Data cable less than 10 meters long, use only one 120 Ohm termination resistor, the one onboard the BMS or the one on the last chain peripheral.
- To use the HCC system remotely, via a VNC program, you must connect the RJ45 port on the back of the Touch HCC Panel to a Router or Switch via an Ethernet cable.

⚠ WARNING!

The MODBUS network **must always terminate at the ends with a 120 Ω resistor, between terminals A and B.** Usually the network terminations are on the one hand the HCC panel and on the other the heat pump. In some configurations the heat pump may not be presents, and then the other extreme of the network will have a MODBUS device (sensor or Floor board), which must have a 120 Ω resistore between the terminals A and B.

Devices initialization

Each device must absolutely have a unique address.

ROOM sensors:

For ROOM sensors see chapter II.

I/O FLOOR boards:

At first power on, each FLOOR board has a default address of 222. To set the address of each FLOOR board, these must be connected **one at a time** via the MODBUS cable to the HCC network. To change the address of the virgin board see paragraph 4.3.2. To permanently set the address you need to power off the FLOOR board. The board should then be set as installed (see 4.3 Installer) and as active (see 4.2 Advanced).

Plant examples.

Example of proper installation

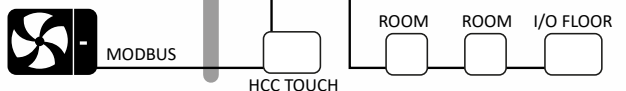

Example of proper installation



Example of incorrect installation

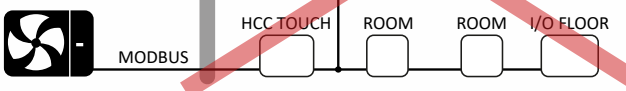

Example of incorrect installation



⚠ WARNING!

If the plant is designed to directly connected the heat pump to a floor system, such as underfloor heating, without intermediate systems, the absence of condensation is not guaranteed.

Termination of MODBUS network.

Always end the MODBUS chain with a 120 Ω resistor, between terminals A and B of the last device in the chain, as shown in figure 3 and 4.

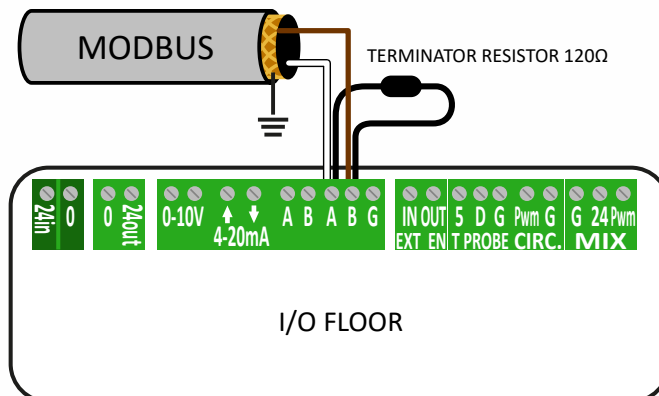

figure 3

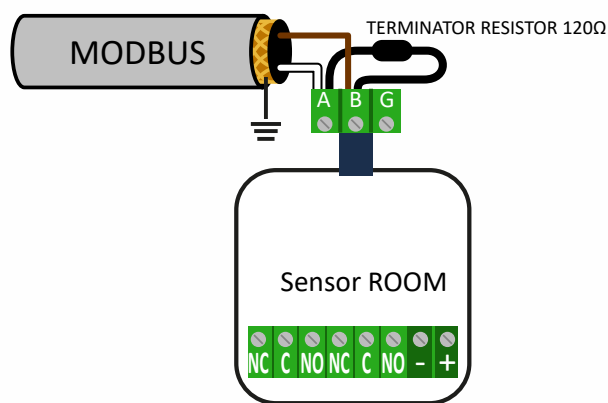

figure 4

Connecting to the Kita heat pump.

If you want to use the PGD1 remote control panel at the same time as the Touch Panel HCC, you must use a **BMS** card, purchased separately.

If the BMS card is present, a 120Ω resistor must be installed at the both ends of MODBUS network. To enable the HCC to function properly, set the communication protocol to MODBUS RTU 485 via the PGD1 panel (mask Ge01).

Referring to the μPC, make sure you **DO NOT** have the terminal ID09 connected to GND as shown in Figure 5.

With this configuration you can simultaneously use the PGD1 control panel and the Touch Panel HCC.

If the HCC touch panel is the only display present and it is connected to the heat pump via the P-LAN port then it is necessary that the ID9 contact of the μPC board is connected to the Ground, as in figure 6.

System overview

This is an example of how to set up the plant.

* The power supply can be external or internal to the heat pump.

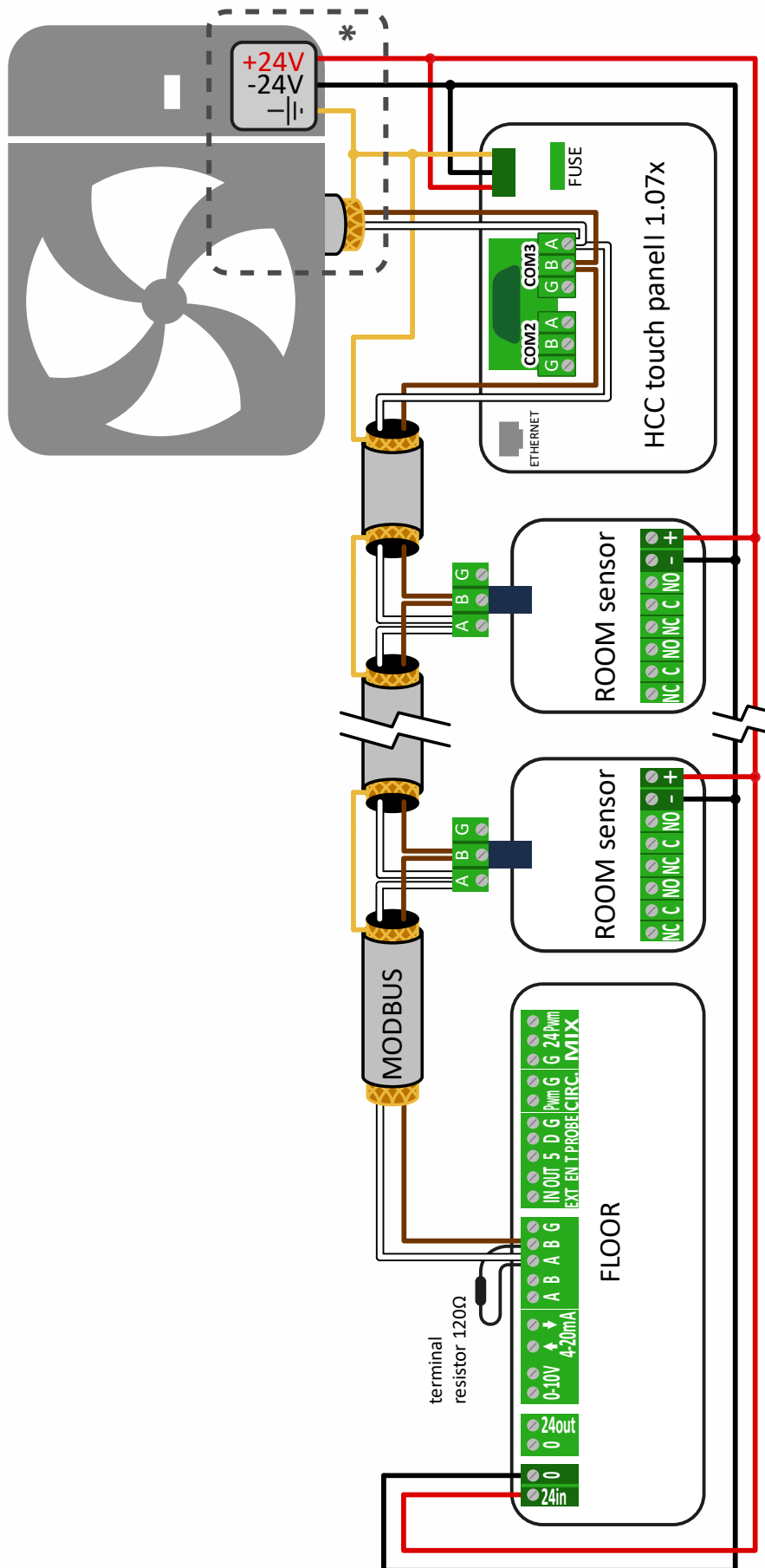

Figure 2

Touch HCC panel connected via BMS



figura 5

Touch Panel HCC connected via P-LAN as the only display

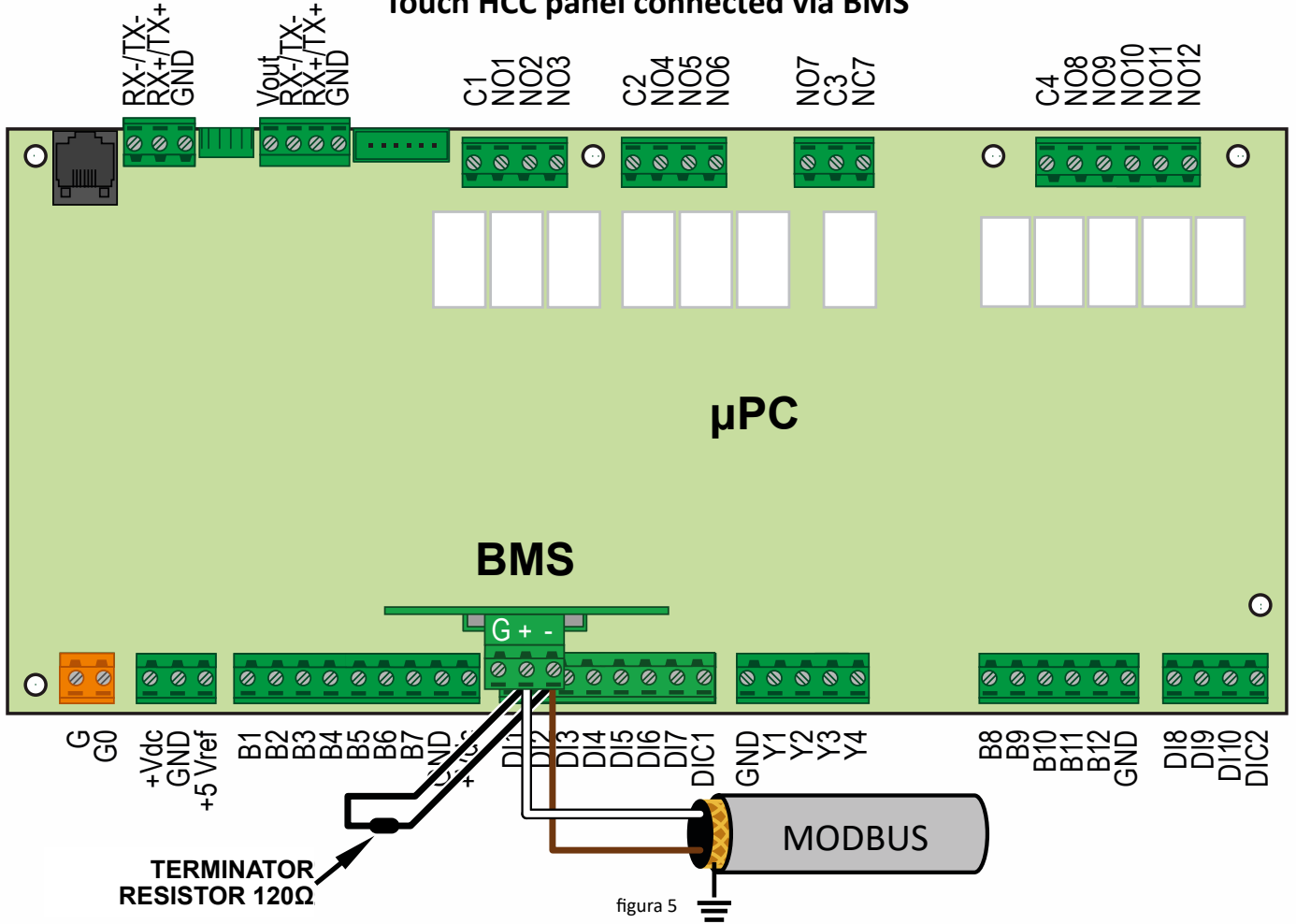

figura 6

Exploded view: PPlan connection (5a) or BMS connection (5b)



- ① Panoramic
- ② Power supply
- ③ Compact lever connector
- ④ Green/yellow shield ground connection
- ⑤a µPC PPlan connection
- ⑤b µPC BMS connection
- ⑥ Shield
- ⑦ HCC touch panel connection

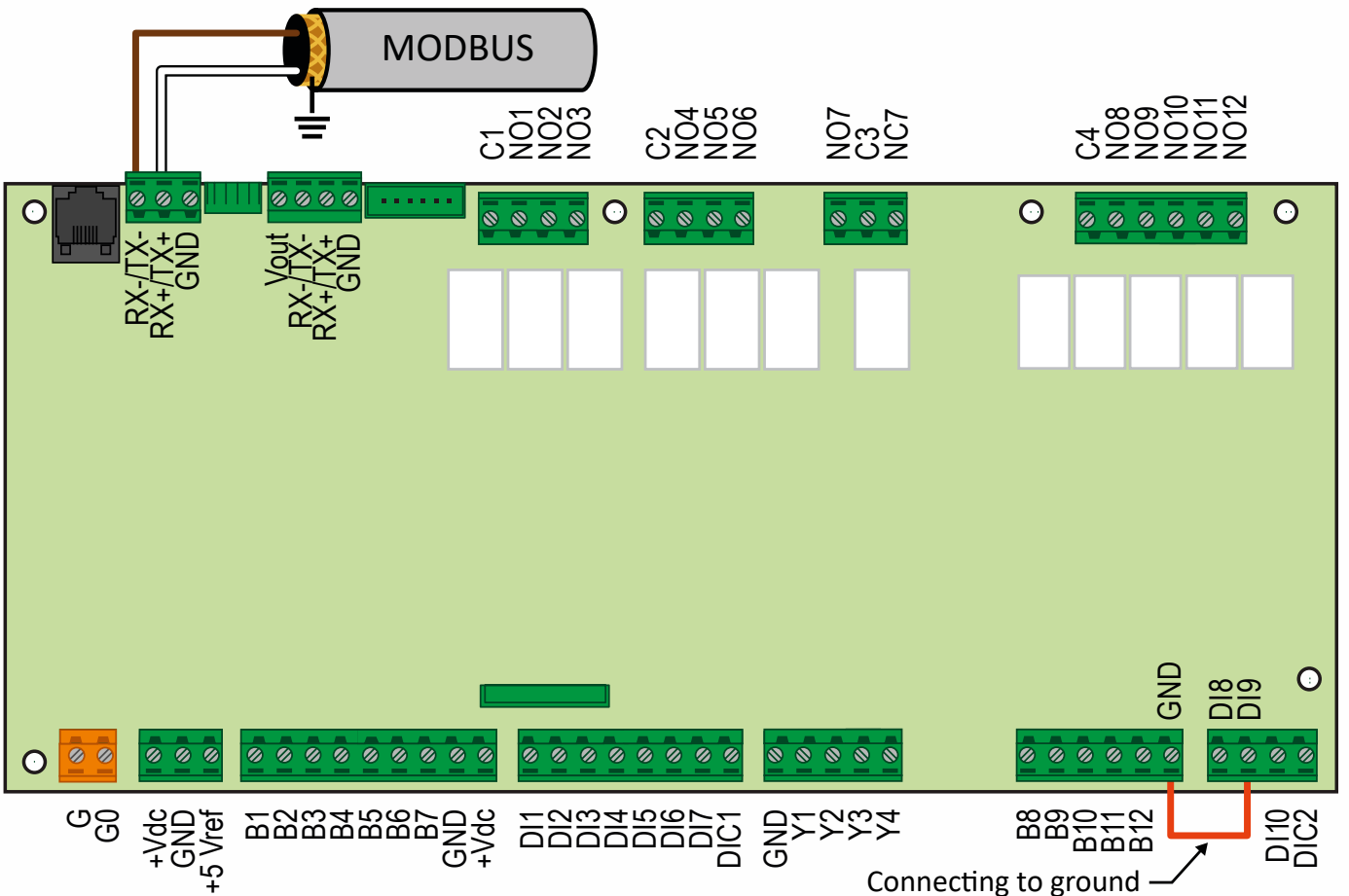
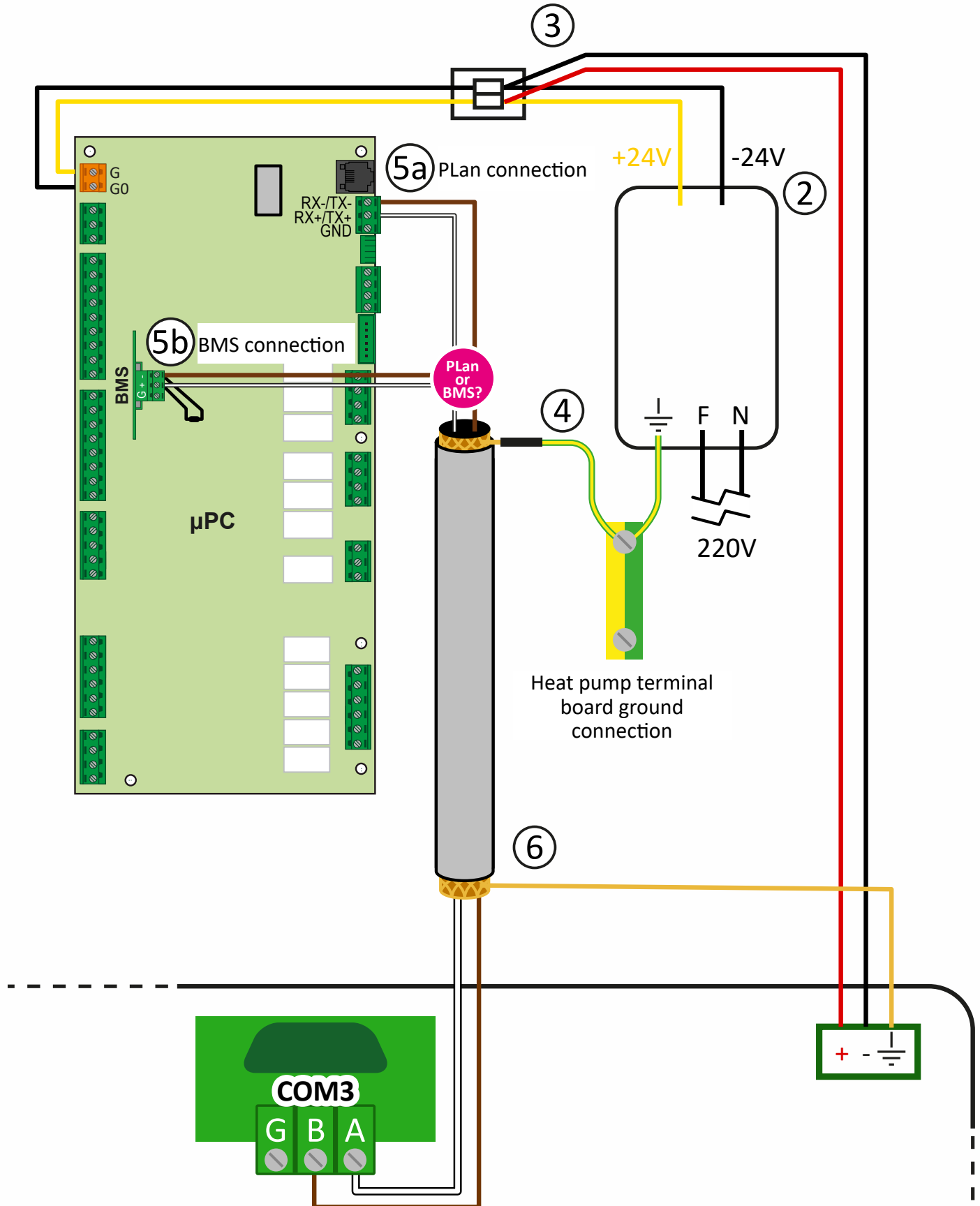

① Panoramic



⑤a µPC PLan connection



② Power supply



③ compact lever connector



⑤b µPC BMS connection



④ Green/yellow shield ground connection

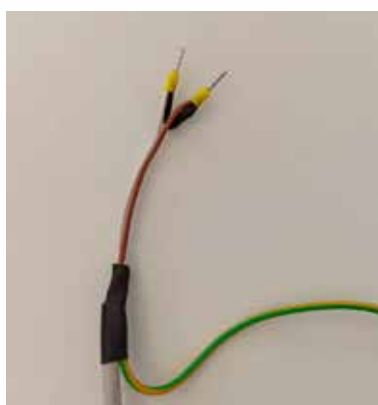

⑥ Shield



⑦ HCC touch panel connection



Watch the video for the K-Touch connection to the heat pump.

Sensore ROOM guide

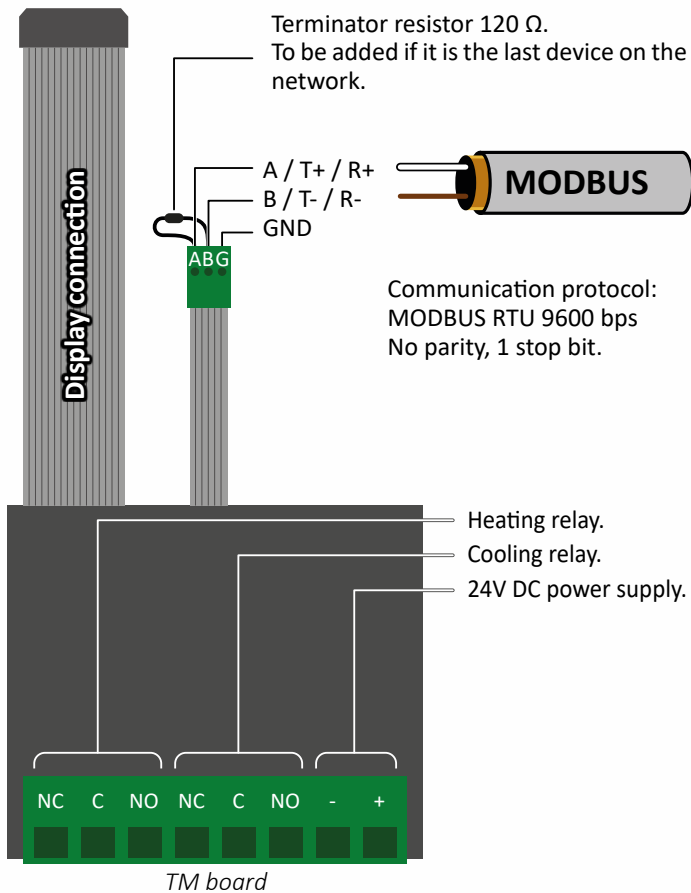

MODBUS REGISTERS

0	Device MODBUS address
1	Temperature probe
2	Humidity probe
3	Dew point indicator
4	Cooling ECO Setpoint
5	Cooling DAY Setpoint
6	Cooling NIGHT Setpoint
7	Heating ECO Setpoint
8	Heating DAY Setpoint
9	Heating NIGHT Setpoint
10	Active Setpoint. If the user is adjusting the setpoint from the sensor (register 15=1), the value in this register will become the new setpoint.
11	Request (0 = off; 1 = on)
12	Cooling mode/ heating mode. 0 = cooling; 1 = heating
13	External temperature
14	Heart bit. Set to 0 cyclically to indicate a present master.
15	Setpoint adjustment. 1 = the user is adjusting the setpoint from the sensor.

⚠ WARNING!

Do not use to directly drive loads with absorption peaks greater than 3W.

**USE A COMMAND RELAY FOR INDUCTIVE LOADS LOWER THAN 3W.
DO NOT USE DIRECTLY TO DRIVE LOADS EXCEED 3W.**

I/O FLOOR board guide

To assign the Modbus address to the FLOOR board see paragraph "4.3.2 set address".

The I/O FLOOR board can be used for several purpose:

- 1 controlling circulators
- 2 controlling control valves
- 3 controlling zone circulators
- 4 Acquire temperatures from the zone collector

1
The board has 8 relay dry contact NC NO outputs with which it is possible to drive heads or circulators or devices that require a dry contact. All relays are independent, usable at low or medium voltage, maximum 10A 230V.

The relays are independent of each other, controllable and programmable (see 4.3.1 ROOM sensor settings).

2
The card provides the control of a zone mixer, PWM or 3 points type.

Use the MIX output for digital valves with PWM control. Use the PHASE OPEN and PHASE CLOSE outputs to connect a mixing valve with 3-point control (neutral, open phase, close phase). The 2 outputs work synchronously and not independently.

3
The PWM signal can be connected to the CIRCULATOR connection port to control a zone circulator with PWM input.

4
Acquired temperatures are used to control the outlet and inlet temperature of the plant (maximum flow temperature, moisture temperature and antifreeze control). To identify the probes you need to heat one, even just holding it in your hand, and see which values change in the readings. Then you can install the probe in the proper housing. To improve the probes performance, it is recommended to use a thermal conductive paste.

! WARNING!

Refer to the HCC manual for power supply and installation of MODBUS communication.

Example of I/O FLOOR board wiring

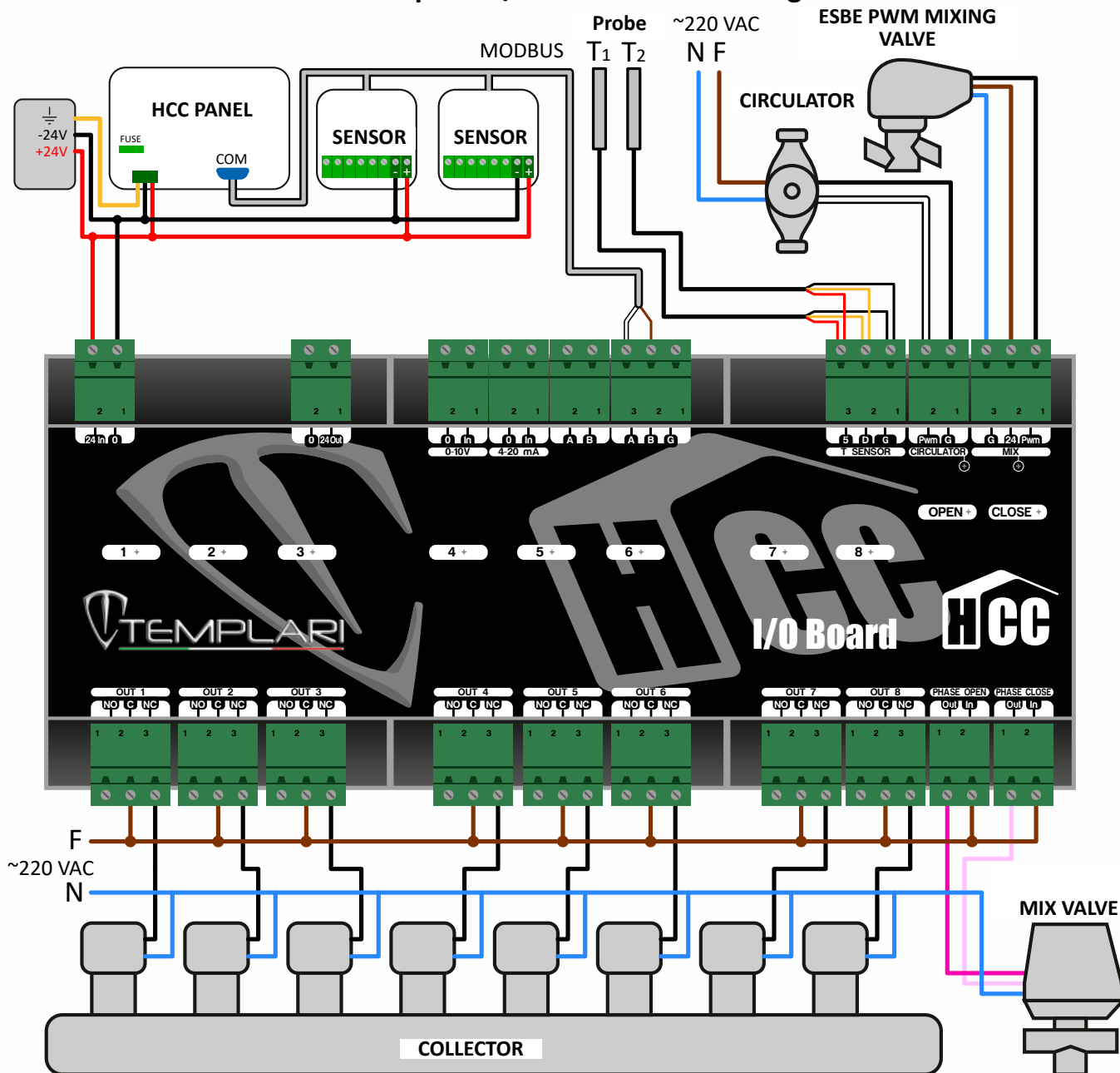

II Address Programming procedure, Temperature offset and Humidity offset for FW versions > 1.2

From version FW1.3 onwards, inside the HCC Room thermostats, it is possible to set temperature offset and relative humidity offset, such as calibration values to optimize readings value for the environment, and compensate for Room installed in bad position.

WARNING!

The manufacturer assumes no responsibility for malfunctions or damage caused to the plant or parts connected to it, caused by the modification or introduction of offset, during installation or subsequent to it.

Address Configuration

- 1 Check that all the HCC ROOM sensors are connected to the Data network and to the 24Vdc power supply line.
- 2 Using the HCC Touch panel go to SETTINGS -> ADVANCED screen (see 4.2)
- 3 Deactivate the sensors to be set, turning off the green boxes relative to these sensors (see 4.2)
- 4 Disconnect the 24Vdc line from the HCC devices.
- 5 Disconnect the 24Vdc power supply connector of the HCC Touch Panel.
- 6 Switch on the 24V line of the HCC devices.
- 7 Wait about 2 minutes for the sensors to go offline (Fig. 1).
- 8 Using the Room sensor, access the "Installation Configuration" menu by simultaneously pressing the UP and DOWN buttons for some time. The menu allows you to choose the various settings based on the buttons pressing time.
 - 8.a In the "Installation Configuration" menu it is possible to modify:
 - Device address (press UP + DOWN for 2 seconds)
 - Temperature offset (press UP + DOWN of 8 seconds)
 - Humidity offset (pressing UP + DOWN 10 seconds)
- 9 Once identified the ADDRESS sub-menu (Fig. 2) press the UP or DOWN key to change the sensor address.
- 10 After completing the address change, wait a few seconds for the Room sensor to return to the offline operation screen (Fig. 1)
- 11 Write down this address and the related area, this will then be entered in the HCC Touch Panel.
- 12 Repeat steps from 2 to 12 for each Room sensor you want to set, and note the address change. The new address is only available after sensor restart cycle.
 - 12.a The modified parameters will be available ONLY AFTER a switch-off cycle and subsequent switching on of the 24V line of the HCC devices.

When the 24V line is switched on again, each sensor shows its address on the display. Check that the new address is correct and unique in the network of Hcc devices.
- 13 After configuring the last ROOM sensor, wait at least 20 seconds and then switch off the 24V line of the HCC devices.
- 14 Connect the 24Vdc power supply terminal of the HCC Touch Panel.
- 15 Wait at least 20 seconds and then switch on the 24V line of the HCC devices again.
- 16 Go to SETTINGS -> ADVANCED -> MANUFACTURER screen (see 4.3), and enter the addresses of each HCC ROOM sensor, according to the address set manually to the that sensor.

If that sensor is physically connected to the Data network, touch the button next to the setted address. You will access the appropriate settings screen (see 4.3.1).
- 17 Go to SETTINGS -> ADVANCED Screen (see 4.2) to enable the newly installed and connected sensors (green ball selected). Select the square corresponding to the installed HCC ROOM sensors. The selected square will turn green and the sensor will be active.
- 18 Wait a few seconds and make sure that the display of the sensor in question returns to the online display (Fig. 3)
- 19 Check the correct reading of the Hcc Touch panel sensors.
- 20 In the event of malfunctions, repeat the procedure from point 3, paying attention to the waiting times indicated.

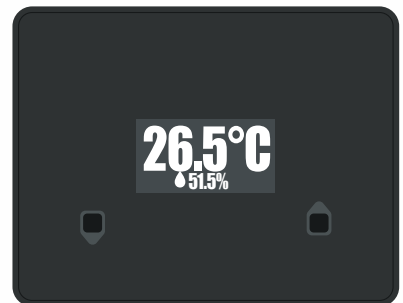

Fig. 1

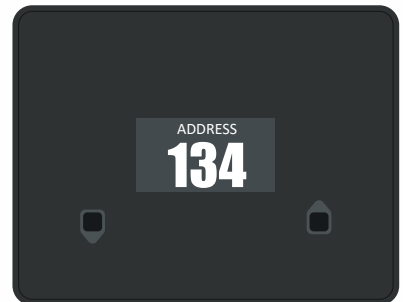

Fig. 2

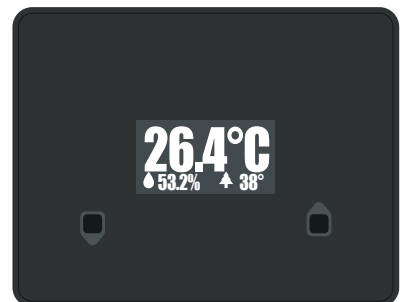
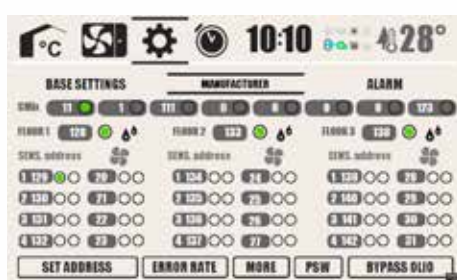
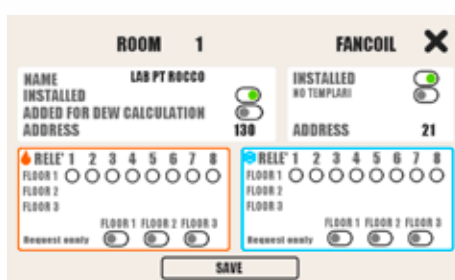

Fig. 3

schermata COSTRUTTORE



schermata IMPOSTAZIONI SENSORE ROOM



schermata AVANZATE



Configuration Temperature offset and relative humidity offset

The setted offset value will represent a constant that is added or subtracted to the sensor's real-time reading.

It is possible to set a temperature offset from -3.0°C to $+3.0^{\circ}\text{C}$, in steps of 0.1°C

It is possible to set a relative humidity offset from -10% to $+10\%$, in steps of 0.5%

WARNING!

The dew point temperature, calculated by the single sensor, is updated considering these offsets, which involve a recalibration of the environmental reading values, which may differ from those generated by the system.

Dew can form on the surfaces (eg floor) in cooling mode.

- 1 Using the HCC Touch Panel access the SETTINGS -> ADVANCED screen (see 4.2)
- 2 Deactivate the sensors to be calibrated by switching off the green panels relative to the sensors.
- 3 Wait about 2 minutes for the sensors to go offline (Fig. 1).
- 4 Using the Room sensor, access the "Installation Configuration" menu by simultaneously pressing the UP and DOWN keys in a prolonged manner. The menu allows you to choose the various items based on the time in which the pressure of both keys is maintained.
 - 4.a In the "Installation Configuration" menu it is possible to modify:
 - 1 Device address (press UP + DOWN for 2 seconds)
 - 2 Temperature offset (press UP + DOWN of 8 seconds)
 - 3 Humidity offset (press UP + DOWN 10 seconds)
- 5 Once the item to be modified has been identified, press the UP or DOWN button to change the size of the interested value (Fig. 5, 6, 7 and 8).
- 6 After finishing the modification of the desired parameters, wait a few seconds for the Room sensor to return to the offline operation screen (Fig. 1)
- 7 Repeat steps from 2 to 6 for each Room sensor on which you want to work.
- 8 Wait at least 20 seconds and then switch off the 24V line of the HCC devices.
- 9 Wait at least 20 seconds and then switch on the 24V line of the HCC devices again.
 - 9.a The modified parameters will be available by the sensor ONLY AFTER a switch-off cycle and subsequent switching on of the 24V line of the HCC devices.
When the 24V line is switched on again, each sensor shows its address on the display. Check that it is correct and unique in the network of Hcc devices.
- 10 When the system is switched back on, using the HCC Touch panel go to SETTINGS -> ADVANCED screen (see 4.2)
- 11 Reactivate the Room sensors by turning on the relevant green boxes.
- 12 Wait a few seconds and make sure that the display of the sensor in question returns to the online display (Fig. 3)
- 13 Check the correct reading of the Hcc Touch Panel sensors.
- 14 In the event of malfunctions, repeat the procedure from point 1, respecting the waiting times indicated.

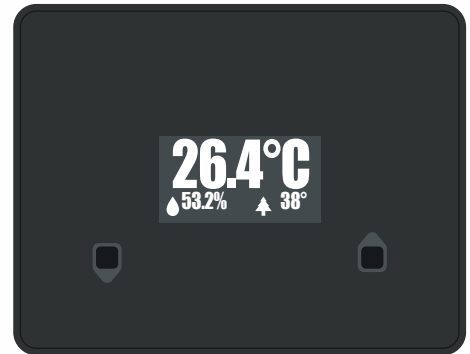

Fig. 3

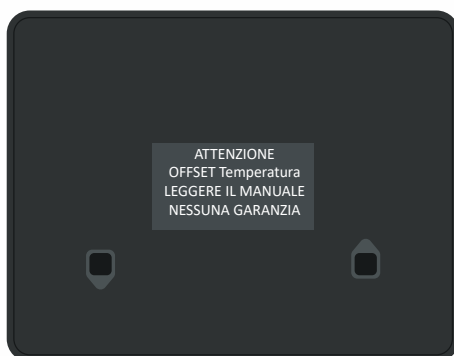

Fig. 4

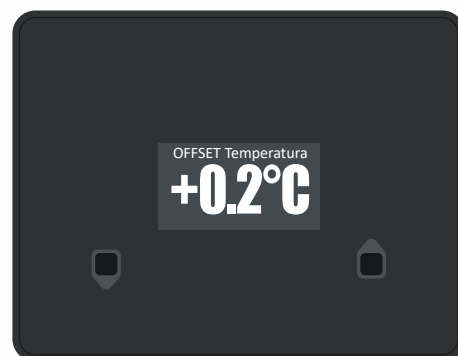

Fig. 5

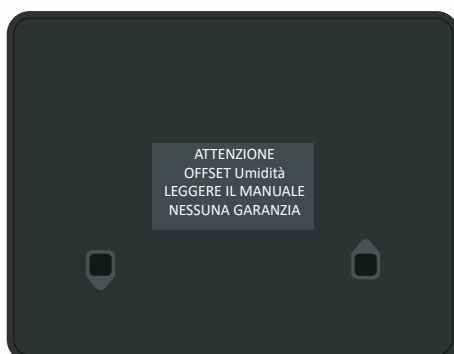

Fig. 6

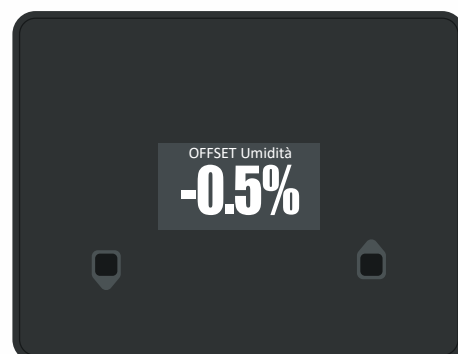

Fig. 7

Errors and Malfunctions

In the event that all of the above steps are not respected, or if the data network is incorrectly connected, malfunctions may occur, solvable by following steps below

The HCC ROOM sensor displays 88.8 ° C and 88.8% . :

Damaged sensor.

Contact services for TS and TM Replacement.

The HCC ROOM sensor displays 0.0 ° C:

Sensor installed but incorrectly configured, or there are problems with data line communication caused by a network failure or incorrect installation

Refer to Chapter III for network data correctness.

- Verify that the address inside the Touch panel and the one stored inside the corresponding HCC ROOM sensor are matching.
- Verify that this address is **unique** and that there are no other devices with the same address.

To check the address stored inside the sensor, disconnect the 24Vdc power supply, disconnect the 24V power supply terminal on the TOUCH HCC panel and switch on the power supply again. Wait for the display of the sensor under test to turn off. A moment before switching off, the stored address will appear.

It is now possible to program the address of the sensor in question by acting on the touch keys.

You can now inspect all the sensors by checking the address stored in each one and, if necessary, modify it where it is needed by using the keys of the HCC ROOM sensor.

After a minute of inactivity The display will turn off. Tapping the keys will turn it on again, making it possible to modify the address.

Once the address setting phase of all sensors has ended, wait until the display of the last updated sensor turns off. Remove the 24Vdc line voltage. This operation allows the sensor to abilitate the newly set address.

- Connect the HCC Touch Panel power terminal
- Turn on the 24Vdc power line and go to: SETTINGS -> ADVANCED-BUILDER screen; proceed to the verification of the addresses of each ROOM sensor, according to the address manually set to the corresponding sensor.
- Verify that the button next to the address setted is selected, if it is physically connected with the Data network (see 4.3.1).

WARNING!

If FLOOR Mixing boards are present, make sure that all Room Sensors refer to the correct mixing zone, otherwise the zones will be malfunctioning.

- Go to: SETTINGS -> ADVANCED screen, to enable the installed and connected sensors (green dot selected), by selecting the square corresponding to the installed ROOM sensors. The selected square will turn green and the sensor will be active.

In the event of a malfunction, check the data network connections in Section (Modbus Data Network Correction).

III Modbus data network check

WARNING!

Before proceeding to check, make sure that the power supply to the 24Vdc line and to the power supply line of the electrothermal actuators of the system have been disconnected.

In the event of malfunctions of the Modbus data network, check the connections according to the following points:

- Make sure that the connections between the BMS board, mounted on the machine, and the various peripherals (Touch HCC panel, HCC ROOM sensor, HCC FLOOR board) respect the connections shown in tab1, Fig1 and Fig2.
- Make sure that the Modbus data cable used is the recommended type.
- Make sure you have inserted the 120 Ω termination resistors, supplied with the Touch HCC Panel, and that you have connected the sheath of the data cable to the ground pole of the power supply.
If the total wire length of the Modbus data line is less than 10 meters, use only one termination resistor, indifferently, on the BMS or on the last peripheral of the chain.
- Make sure there are no copper wires that short-circuit the A and B signals or the A and B signals with the braid.
To verify this use a Multimeter in electrical continuity position, or Ω scale, and make sure that there are no short circuits on the Modbus data line. In Ohmic scale position there will be an impedance of about 60 Ω in case there are both termination resistors, or about 120 in case there is only one termination resistance.
- Check the electrical continuity of the plug-in terminal relative to the Modbus data line, and eventually replace it with a working one.

IV First start

During the first start of the panel, the product serial number is requested. For correct operation of all services it is necessary to enter the correct serial number, which can be read on the back of the panel or on the adhesive label on the box. Normally the panel is supplied with the serial number already registered, but after an update it may be necessary to reinsert it, therefore it is recommended, during maintenance, to always have the serial number at hand.



1 INTRODUCTION

The HOUSE CLIMATE CONTROL monitors for the management of home comfort is born with the aim to make the climate management in your home as easy and intuitive as possible.

Using the touch panel you can navigate the screens, separated into 4 sections ENVIRONMENTS, HEAT PUMP, SET and SCHEDULE, and through them you can govern every aspect useful for comfort and scheduling according to your needs. All working on different room environments. Depending on the plant built, the sections ENVIRONMENTS and HEAT PUMP may not be present.

1.1 HOW DOES IT WORK

The system can consist of:

- HCC touch panel, which will allow you to monitor and set all operating parameters;
- KITA heat pump, which will work to generate the ideal temperature;
- FLOOR I / O boards, which handle mixers;
- ROOM sensors for environments that works for monitoring the parameters of the individual rooms.

The system is able to handle up to 3 different I / O FLOOR boards separately and up to 12 controllable environments. In case it is not necessary to work on many environments, the sensors can also be installed independently, without an I / O FLOOR board.

1.2 Profiles

To meet the savings requirements and then optimize the energy expenditure of climate devices, you can set the system and environments to work in 3 different profiles: ECO, DAY and NIGHT. Each of them is divided into 2 different values depending on whether the located system is working in heating mode or cooling mode. These profiles can work at different temperatures and for each one of them you can set the setpoint, or the temperature to be reached. In this way it is possible to select the preset setpoint for each profile and with a simple touch switch from one to another (see 3.2 and 4.1).

Once you select one, all active environments will work using the same profile. However, each setpoint can be set individually for each environment. This means that even if, for example, all environments will work with ECO profile, however, the ECO Setpoint of an environment may be different from the ECO Setpoint for another environment, as well as the ECO setpoint in cooling will be different from ECO Setpoint of the same environment but in heating mode.

We recommend using **ECO** profile for Setpoint to make the heat pump do a little work, to be used when there is no one in house for long periods of time, such as during the holidays, but you do not want to switch off the system. When no profile is selected, on first start the default is ECO profile. On default this setpoint is set at **20 ° C** for heating and **25 ° C** for cooling.

We recommend using **DAY** profile for everyday Setpoint, when you want to make the house comfortable for the people living there. On default this setpoint is set at **22°C** for heating and **23,5°C** for cooling.

We recommend using **NIGHT** profile for night use Setpoint, when the need to work on the climate is less. On default this setpoint is set at **18°C** for heating and **26°C** for cooling.

There is a fourth profile, **MANUAL**, which is activated when the scheduling is deactivated (see chapter 5). The first 3 profiles are used only while the scheduling is active, but when you switch to manual this profile comes in place, which can be used for special or temporary Setpoint, both for the plant and for the sensors.

When manual profile is active, also the mode automatically switches to manual (see 1.3 Mode) and all manual setpoint for individual environments becomes active.

If scheduling is working and no profile is active, the heat pump is not switched off, but it will work using default setpoint in order to consume less energy as possible. In this specific case, the setpoint of the ambients will no longer be visible.

Example of operation

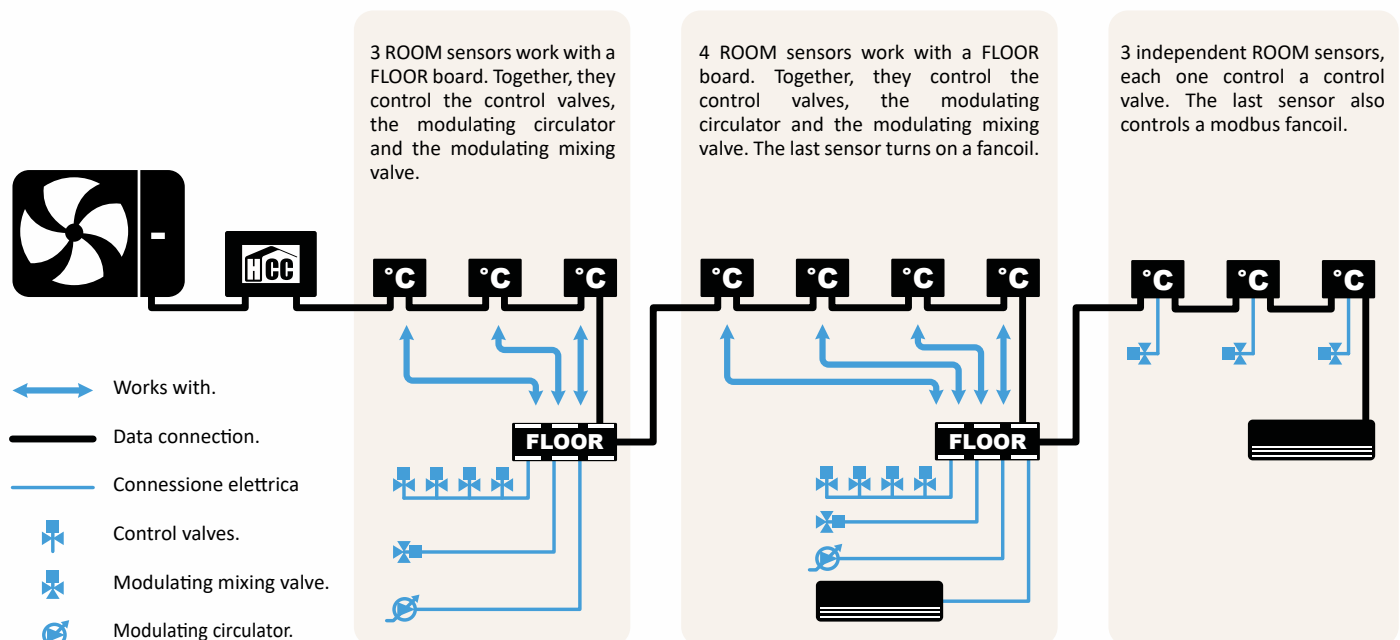

1.3 Mode

The heat pump can work in three different modes, WINTER, SUMMER and DHW (see 3.1 and 3.3).

WINTER is used when you want to generate heat, SUMMER is used when you want to generate cold air, DHW is activated in combination with the previous if you want to produce at the same time hot water for domestic use. Each of these modes is associated with a different setpoint and the heat pump will use them to work properly.

These 3 modes are combined to ECO, DAY and NIGHT profiles, so the Setpoint WINTER - ECO is different from the Setpoint WINTER - DAY.

Once set these three setpoint, with a touch you can activate the desired one for the plant. After that, the pump will begin to work to get the water to the set temperature to then distribute it in environments that request it.

The default values are WINTER 35°C, SUMMER 12°C, SANITARY 47°C, for all 3 profiles.

For the mode too, such as profiles, there is a manual setpoint.

1.4 Changing setpoints via ROOM Sensors

By default, changing the setpoint is enabled only through the HCC touch panel, but you can also enable changing from the installed sensors.

To enable the setpoint modification directly from the sensors, you have to go to the Other screen (see 4.3.3) and turn on the appropriate flag.



To enter in "Setpoint Change" mode from the sensor, you must press the 2 buttons on the sensor simultaneously for at least 2 seconds. The current setpoint will then be displayed. It is now possible to modify it by increasing it using the right button and decreasing it with the left button, with 0.5 ° steps.

If the sensor buttons are not pressed for more than 2 seconds, it automatically exits the "Setpoint Change" mode and switches to the standard screen.

This screen is displayed for 60 seconds, after which the screen will go into stand-by and will be reactivated at the first touch.

1.5 Menu bar overview



- 1 the 4 icons of the tabs used in the panel: ENVIRONMENTS, HEAT PUMP, SETTINGS and SCHEDULE. Each section can have multiple screens.
- 2 the current time. Tapping it a keyboard will appear and you can use it to change the time.
- 3 info icons:
 - a - when lit, it indicates that the antifreeze is active to prevent freezing of pipes. If the antifreeze is active, all sensors and I/O board installed, if disconnected, will be reconnected to ensure the flow of hot water.
 - b - when lit, it indicates that ECO profile is active
 - c - when lit, it indicates that DAY profile is active
 - d - when lit, it indicates that NIGHT profile is active
 - e - communication. As long as it turns on and off by changing color, the panel is communicating with devices:
 -  panel is waiting
 -  reading from devices
 -  writing on devices
 - f - if it is green it indicates that booting has been successful, if it is red indicates that booting did not end properly and some features are unavailable.
 - g - when lit (yellow) it indicates that the scheduling is active.
 - h - when lit (yellow) it indicates that the manual profile is active. In this case the icons of the profiles will not turn on because the user's decisions will override them.
- 4 the current outside temperature.

2 ENVIROMENTS

The screens of the environment section are designed to monitor and set all the useful values for managing comfort in individual environments.

2.1 Enviroments list

The first page shown in the ENVIRONMENT section is the enviroment list, where you can see which environments are installed and active. By touching the icon of one of the active environments, you can jump to the screen for that environment.



2.2 Environment

Use the PREVIOUS and NEXT buttons you can navigate through all active environments. In order to view an environment, these must be **installed** and selected as **active** in the ADVANCED SETTINGS screen (see 4.2 and 4.3).

If no environment is selected as present the only visible screen in this section will be an empty enviroment list.

The room screens contain all the information necessary to monitor the individual environment.

The color of the house indicates whether the environment is working in cooling mode (blue) or warming (red).

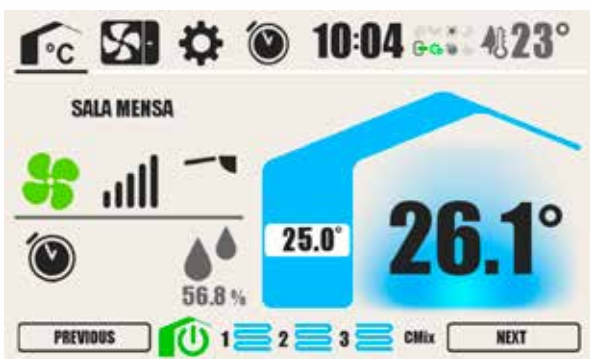

Fancoil. If the icon is on (green) it indicates that the environment will work also using the installed fancoil.



Speed of the fancoil. If you have a fancoil provided by Templari, the speed can be changed: Low, Medium, Maximum and Auto.



Louver swing setting. If you have a fancoil provided by Trmplari, the louver setting can be setted in 4 different angles: they can be moving or they can be stationary.



Scheduling (see Chapter 5). The clock icon indicates that the system is working on scheduling mode, while the hand indicates that it is working in manual mode. Tapping the icon you can switch from one function to another.



Radiant. Tapping the icon you can get to the mixer screen (see 2.4). If the icon is on, the system is running and the color indicates whether it is in cooling (blue) or heating (red).



Humidity. Indicates the percentage of humidity recorded in the environment.



Active setpoint. The system will work to bring room temperature to this temperature. Touching the number, the setpoint change screen will appear, showing the setpoint of all profiles in that environment (for profiles see 1.2, 3.2 and 4.1).



Temperature sensor. Indicates the ambient temperature recorded by the sensor. If there is a light halo behind it, then the system is working to bring that environment to the temperature indicated in the active Setpoint. If the light is blue it is working in cooling mode, if it is orange it is working in heating.



Plan ON/OFF. Touching this icon you will turn on or off the plant. When the plant is off, the heat pump is still powered and on, but all ambient are forced to set their request to 0.

2.3 Setpoint change

Touching the active setpoint indicator of an environment will open the setpoint change screen of that environment. In this screen you can see all the environmental setpoints: Summer Eco, Summer Day, Summer Night, Winter Eco, Winter Day, Winter Night and Manual. Use the + and - buttons to change the setpoints and press OK to confirm the changes. The double gray bar indicates which profile is currently active.

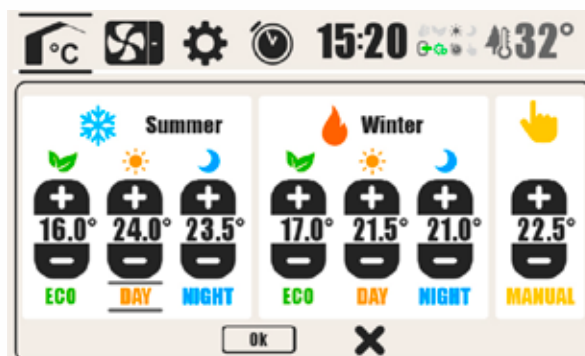

2.4 Mixer

By touching the radiant icon on the screen of any environment, you can open the mixer screen.

The mixer color indicates whether the plant is producing hot (orange) or cold (blue) water.

In this screen you can monitor the most important values with which the mixer works.



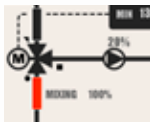

Opening of the 3-way mixing valve. 100% indicates that the totality of the water is taken from the water produced (buffer or heat pump), 0% indicates that the water used is completely recovered from the return of the plant.



Percentage of circulator working. It represents the speed of the water passing through the radiators. Under normal conditions, 7% is the minimum and 100% maximum.



Outlet. The outlet water temperature



Inlet. The inlet water temperature.



Maximum permitted outlet temperature. Passing this temperature will trigger an alarm. It is possible to modify it, but it is recommended to maintain 35°C.



Minimum permitted outlet temperature. The system will work to prevent the outlet water temperature from being lower than the one shown here. In cooling mode it may be the highest dew temperature registered by the ROOM sensors connected to the I/O FLOOR board, which prevents the formation of dew in the cooled environments, or it may be an arbitrary value (see 4.3.3 Builder).



Delta. Indicates the difference between inlet and outlet temperature inside radiating system. By setting a value, the system will try to work more or less quickly to maintain that difference. Higher values will slow down the circulator, lower values will speed it up.



Active relay. These icons indicate (green) the relays currently active on the FLOOR I/O board.

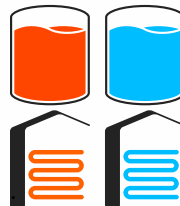

if it is RED then it is off. If the outside color does not match the internal color then the pump is passing from one state to another: only when the two colors match the heat pump has passed to the new state. If the external color is not visible then there are communication problems with the heat pump.

Buffer. It shows the water temperature that the buffer stores to heat or cool the house. Color indicates whether you are producing hot (red) or cold (blue) water. In case the plant has no buffers then the icon will be replaced by a radiating system



Domestic hot water buffer. It shows the water temperature that the buffer stores to heat the domestic hot water. Clearly, in order to produce sanitary hot water it is necessary to select the **DHW mode** (see 3.2 Pump settings) and that there is a dedicated puffer.



The arrows indicate where the produced water is directed. When the pump is producing technical water, the arrows appear on the left side, when it produces domestic hot water the arrows appear on the right side. The temperature inside is the outlet temperature.



Winter mode. When turned on, indicates that the heat pump is producing hot water.



Summer Mode. When turned on, indicates that the heat pump is producing cold water.



Sanitary hot water. When turned on, it indicates that the heat pump will also produce domestic hot water.



Circulator. When turned on, indicates that the circulator is running and the water is circulating in the plant.



Compressor. When turned on, indicates that the compressor is running and then hot or cold water is produced, according to the active mode.

38.3% 06.3 kW in 1.8 kW

Questi valori indicano, quando visibili, da sinistra a destra, potenza del compressore espressa in percentuale, potenza termica erogata, potenza totale assorbita.



Settings. Tap this button to switch to the heat pump settings screen (3.2).



Reserved menu. By tapping this button, you can access a menu reserved only for employees. Access is password protected.



House Request. If air controlled compressor function is active (see 4.3.3), this number is displayed, showing the percentage of request that the HCC touch panel passes to the heat pump compressor.

3.1.1 Overview

Tapping the central heat pump icon will display the OVERVIEW screen. In this screen you can monitor many of the functions of the heat pump and sensors connected to it.



Power. Tap the icon to turn the pump on or off. If the icon is GREEN then the heat pump is on,

3 HEAT PUMP

The HEAT PUMP section is dedicated to the most important heat pump functions and is divided into subcategories: BASE and PUMP SETTINGS.

3.1 Base

In this screen you can monitor the current operation of the heat pump.

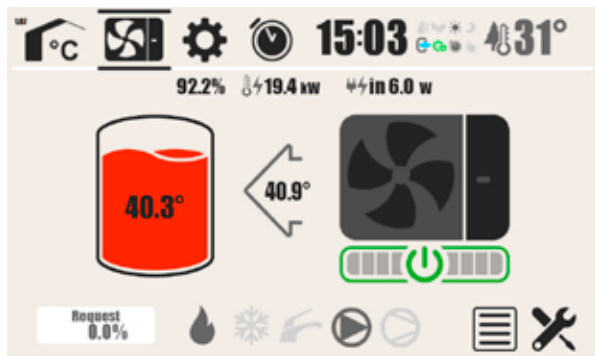

OVERVIEW					
Subcooling	40.3 °C	Scarico	65.0 °C	EEV	89.0 %
B2	9.7 °C	Aspirazione	12.4 °C	SR	4.7 °C
B3	25.0 °C	Bassa Press.	9.1 bar	IRL	0.0 %
B4	12.8 °C	Evaporazione	7.7 °C	OSH	27.7 °C
B5	50.5 °C	Alta Press.	21.7 bar	COP	3.9
B6	64.4 °C	Condensazione	37.4 °C	Δt to start	0 sec.
B7	10.1 °C	Portata	50.5 l/min	Lim. term.	120.0 rps
B8	28.2 °C	Pot. Ventola	125 W		
Heat Pump Percentage		0.0 % Compressor speed: 40.7 rps			

Lim. term. 120.0 rps

Thermal limit. Returns the maximum speed of the compressor. If the exhaust temperature is too high, the maximum speeds will decrease and the gray bar at the bottom will light up.

40.7 rps

Final Rps. Current rotations per second of the compressor. If the air controlled compressor function is active, the gray bar below lights up.

3.2 Heat pump settings

By touching the wrench icon on the Base screen, you can access the Heat Pump Settings screen.

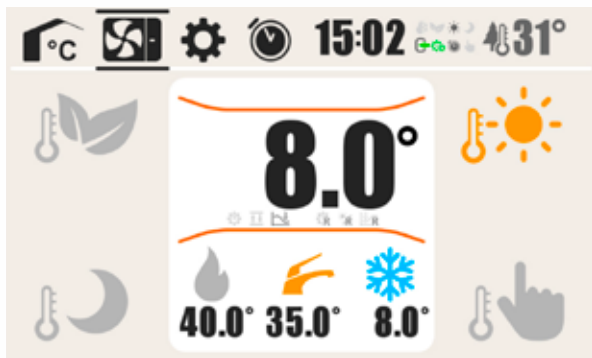

Profiles set point. Tapping one of the icons will display a pop up to set the heating, cooling and domestic hot water setpoints for that profile.



Mode. When turned on, indicates which mode is in use, Winter, Summer, or DHW. Tap one of the icons to enable or disable that mode. The bottom temperature represent the setpoints for that mode. Touching any of these temperatures will display the pop up to set the profile setpoints currently active. **If the compressor is running, it is not possible to switch from one mode to another, except for the DHW.**



Manual set point. Tapping the icon will display the pop up to set the manual heating, cooling and DHW setpoints. With this pop up you can also turn the manual profile on or off (vedi 1.2).



Active setpoint. In the middle of the screen you can see the current active setpoint used by the heat pump. If Climatic Curve or Optimizer are active, the displayed value may differ from those shown below the mode icons. Touching the displayed value will show the Climatic Curve screen. At the bottom of the active setpoint are Climatic Curve and Optimizer icons. If one of the icons is black and not gray then that feature is active.

If the air controlled compressor function is active (see 4.3.3), the screen will appear differently and only the profile setpoint can be changed.

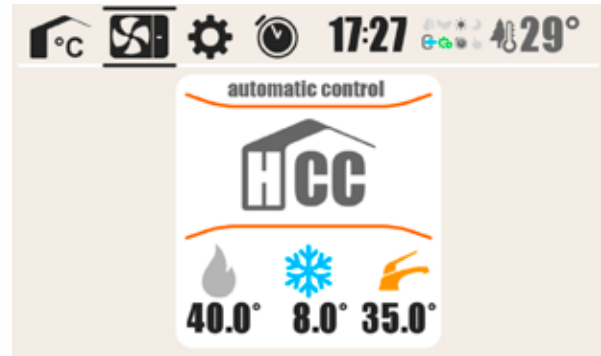

3.2.1 Climatic curve

In this screen you can activate the climatic curve and set its operating values.

The climatic curve is a function to vary the setpoint in use based on the outside temperature, so that the heat pump works only when it is really needed.

⚠ WARNING!

If the heat pump is already using its' own climatic curve, be sure to turn it off before turning this climatic curve on.

Graph.

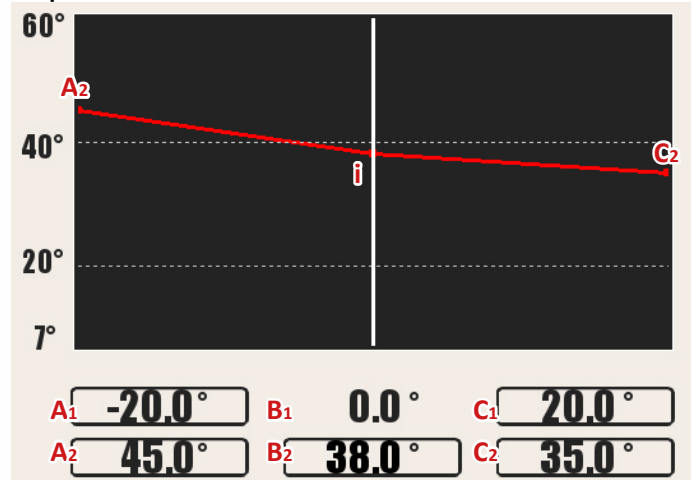

The climatic curve calculates a Delta that will be combined with the setpoint currently in use.

A₁. The lower average external temperature of the graph. At this outdoor temperature, or lower, the starting point for the Delta calculation will be the temperature indicated by A₂.

B₁. Indicates average outdoor temperature of 0 °. With an external temperature of 0 ° the desired temperature for calculating the Delta will be B₂.

C₁. The highest average external temperature of the graph. At this outdoor temperature, or higher, the Delta calculation set point will be C₂.

The graph of the climatic curve shows on the vertical axis the temperature to be generated and on horizontal axis the average external temperature.

The graph draws a curve (red line) that intersects (i point) with the current average external temperature (white line). The leftmost point of the curve (A₂) represents the desired maximum delivered temperature, while the rightmost point (C₂) is the minimum desired temperature. The delivered temperature difference (A₂ - i) is the final

Delta that will be combined with the current setpoint.

This means that if my current setpoint is the same as shown on A₂ then the graph will correspond to the current operation, but if I change my current setpoint the resulting effect is similar to translating the curve.

 **On/Off.** By tapping the icon you can activate or deactivate the climate curve. Once activated, the final setpoint will change depending on the curve and outside temperature, and will replace the setpoint in use based on the generated delta.

 **External temperature.** Reports the average outdoor temperature calculated over 24 hours. This value is used as a parameter for calculating the climatic curve.

Base Setpoint **35.0°** **Base setpoint.** Shows the setpoint value of the mode currently in use, without any climatic curve changes.

Δ **-8.4°** **Delta.** Once the climatic curve is activated, here is how much the base setpoint will change.

Final Setpoint **26.6°** **Final setpoint.** Once the climatic curve is activated, the delta will be applied to the base setpoint. The result is the new setpoint that will be used by the heat pump.

 **Optimizer.** If the icon is light gray then it is turned off, if it is black then it is running. By tapping the icon you will open the optimizer screen where you can activate it.

 **Close screen.** By tapping this icon you can return to the heat pump settings screen.

3.2.2 Optimizer

In this screen you can activate the optimizer and set its operating values. The optimizer is a function that allows the heat pump setpoint to be varied based on the outside temperature, raising it when the outside temperature is higher, so it is more favorable to heat exchange, or lowering it when outside is colder, when the exchange heat is unfavorable.

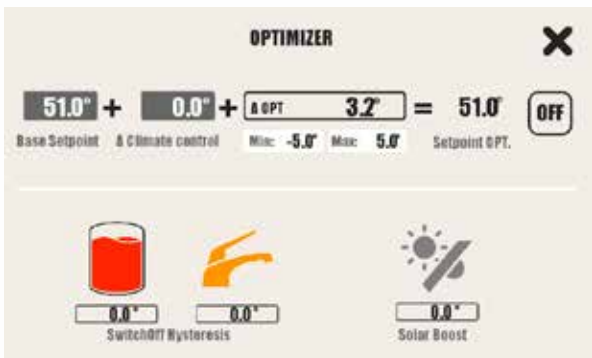

 **On/Off.** By tapping the icon, you can enable or disable the optimizer. When active, the final setpoint will change depending on the outside temperature and will change the setpoints set in the modes, without exceeding the limits set by Max and Min.

51.0° **Base Setpoint, Delta Climate Curve.** In these two boxes, it is possible to read the heat pump starting set point as well as the variation given by the climatic curve, if activated.

Δ OPT **3.2°** **Delta Optimizer.** If the optimizer is active here you can see the value by which the current base setpoint will be translated.

Min. The maximum value to subtract from the base setpoint. It is not allowed to subtract a greater value than this.

Max. Maximum value to be added to the base setpoint. It is not allowed to add a greater value than this.

= 51.0° **Setpoint OPT.** Here is reported the final value after all variations.

 **Shutdown hysteresis.** Keep idling until the required set point.

 **Solar boost.** If Digital Input 6 is closed for thermal solar contact, the setpoint is increased by the set value.

 **Close screen.** By tapping this icon you can return to the Climatic curve screen.

4 SETTINGS

In this section you can find more in-depth specifications for plant management and is divided into 4 screens: BASE, ADVANCED, BUILDER, ALARM.

4.1 Base

Here are the most common settings for plant management.



 **Scheduling** (see chapter 5). The clock icon indicates that scheduling is active while the hand indicates that the system is working manually. By tapping the icon you can switch from one function to another.

 **Profile.** The lit icon indicates if the ECO profile (leaf), DAY (sun) or night (moon) is active. **If, when scheduling is active, none of these icons is on, the heat pump is not off, but works to consume the minimum possible.**

 **Change language.** This icon shows the flag representing the language currently in use. By tapping the icon, you access the Language Change Screen to select the language you want.

 **Fancoil management: not hotter than.** If the system is connected to fancoils, it is possible to determine whether to activate it or not depending on the water temperature produced. In this case, if producing cold water, the fancoil

will only activate if the water has a temperature equal to or less than the indicated value. Touching the numeric value will display a numeric keypad and you can set a new value.



Fancoil management: not colder than. If the system is connected to fancoils, it is possible to determine whether to activate it or not depending on the water temperature produced. In this case, if producing hot water, the fancoil will only activate if the water has a temperature equal to or higher than the indicated value. Touching the numeric value will display a numeric keypad and you can set a new value.

SAFETY OUTLET

35.0°

Maximum outlet temperature: If mixing management is not active, this value indicates the maximum outlet temperature delivered by the heat pump. In this case the temperature also becomes the maximum outlet temperature allowed for the I/O FLOOR boards (see 2.4).



Fancoil and mixing activation: The 2 icons are used to activate the use of fan coils (top button) and mixing (bottom button). For a fancoil or a FLOOR mixing board to be usable it must be installed and enabled. As an alternative it is possible to use fan coils and mixers not supplied by Templari. **In this case the alternative cards cannot be completely controlled by the HCC system.**

Activate

Anti-legionella activation. Once activated, the anti-legionella cycle will take place on the days and times indicated, remaining active for a set number of hours. During the cycle the resistance temperature rises up to a selected threshold.

Starting time 0

Starting time. This is a value from 0 to 23 and indicates the time in which the cycle will start.

Activation set point 65.0°

Activation setpoint. When the cycle is active, this is the minimum temperature value for the integrative resistance of the sanitary puffer.

SwitchOff Hysteresis 10.0°

SwitchOff Hysteresis. When the cycle is active, this is the maximum temperature value for the integrative resistance of the sanitary puffer.

Time spent at set temperature 1

Cycle time. The anti-legionella cycle, once the resistance has reached the designated temperature, will last for the number of hours reported here.



Active days. The days selected will be the days when the cycle will be active.

4.1.1 Change language

In this screen you can set language used by tapping the flag of the chosen language.



4.1.2 Anti-legionella settings

In this screen it is possible to set the time and setpoint for the anti-legionella cycle. If the system has a domestic water puffer, this function **must** be activated and the digital output 8 of the µPC must be connected to the integrative resistor of the puffer via a relay contactor.

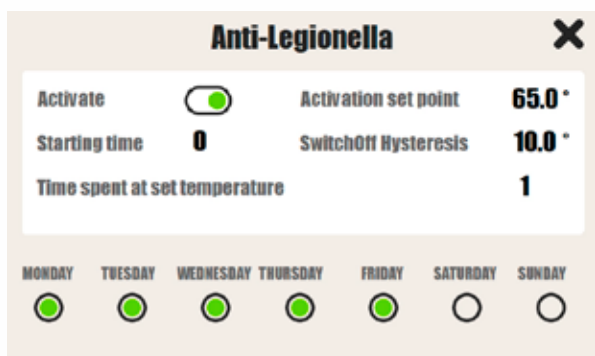

4.2 Advanced

In this screen you can set more specific functions. The screen is password-protected and only competent personnel can access it. The plant can work with up to 12 ROOM sensors and 3 I/O FLOOR board. Each sensor can be associated with a fancoil. All is summed up by the screen graphics.

The sensors and mixers are in constant communication with the HCC panel to be able to work best, but if for some reason more than 10 consecutive read and / or write errors occur on a device, that device will be disconnected to avoid HCC working with a potentially damaged or defective component (see 4.4 Alarm).

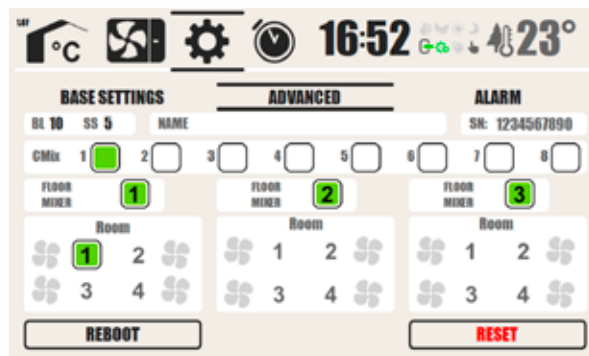

BL 10 SS 5

Screen saver. BL indicates how many minutes of inactivity the panel will turn off the monitor. SS indicates after how many minutes of inactivity the screensaver will start.

NAME

Panel name. It is possible to set a name for the HCC panel with a maximum of 20 characters. This name will identify it during remote monitoring.

SN: 1234567890

Serial number. Here you can see the serial number of the panel, inserted during the first

start-up. The serial number will identify the panel in some of the remote services.



Floor mixer. If a I/O FLOOR board has been installed, it have to be enabled by touching the icon. Otherwise the card will be inactive. If non-Templar mixers are used, this procedure is not necessary.



CMix abilitate. If a CMix board has been installed, it have to be enabled by touching the icon. Otherwise the card will be inactive.



Sensor and fancoil. If a sensor is installed, here you can indicate whether to work with it or not, by tapping the icon. Next is the fancoil icon. If a fancoil is installed in the same room where the sensor is installed here it is possible to indicate whether the sensor will work in accordance with it or not, by tapping the icon. If the fancoil icon is light gray then there is no fancoil installed for that environment, if it is dark gray then it has been installed and is present, if it is light on then it is selected as active and will work in accordance with the sensor.

It is also possible to associate more fancoil with a single sensor. If more fancoils are present and active in the same sensor quartet, but one of the active fancoils does not have a sensor icon on his side, then that fancoil will work in accordance with sensor number 1. This way, you can associate to sensor 1 up to 4 fancoil at the same time.



Reboot. By tapping this button the HCC touch panel will restart.



Reset. Toccando questo pulsante e confermando il reset nella seguente finestra di conferma, il pannello HCC verrà riavviato e tutti i valori verranno resettati a quelli di fabbrica.

4.3 Builder

This screen is password protected and only qualified personnel should access it.

From here you can access all the settings required for the installation of the system.

WARNING!

Every time a peripheral is installed, the installation must be notified to the system by switching on the button on this screen. If not, the system will not work properly and could lead to damage to the system.

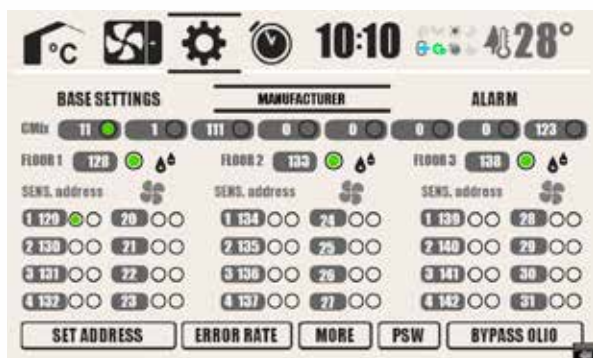

MODBUS mixer address. Here you can see and change the address used in the MODBUS network to communicate with the installed FLOOR I/O mixer board. Once the mixer is installed, to notify to the panel, touch the button to lit it on. A lit off button indicates that a mixer with that address has not been installed. If the mixer is not provided by Templars, this procedure

may not be necessary.

NOTE: As the default value, mixer addresses are 128, 133, and 138.



MODBUS sensor address. Here you can see and change the address used in the MODBUS network to communicate with the ROOM sensor installed.

The left-most dot indicates that a sensor has been installed, the right-most dot indicates that it is valid for dew calculation (see 4.3.3 More).

Once the sensor is installed, to notify the panel, it is necessary to touch the line of that sensor to open the screen dedicated to it and press the button indicating that it has been installed (see 4.3.1 ROOM sensor settings).

NOTE: The default values for the sensor addresses are 129, 130, 131, 132, 134, 135, 136, 137, 139, 140, 141, 142



MODBUS fancoil address. Here you can see and change the address used in the MODBUS network to communicate with the installed fancoil. The left-most dot indicates that a fancoil has been installed, the right-most dot indicates that it is not a fancoil supplied by Templari. Fancoil not supplied by Templari are then interfaced to the system with a Templari expansion card and not all the functions can be available.

Once the fancoil is installed, to notify the panel it is necessary to touch the row of that fancoil to open the screen dedicated to it and press the button indicating that it has been installed (see 4.3.1 ROOM sensor settings).

NOTE: The default addresses used for fancoils are from 20 to 31.



Here you can see and change the address used in the MODBUS network to communicate with the installed CMix. Once the CMix board is installed, to notify to the panel, touch the button to lit it on. A lit off button indicates that a CMix board with that address has not been installed.



Set address. By tapping this button you will go to Set address screen.



Counter. By tapping this button you will go to Counter screen. In this screen it is possible to read how many reading or writing consecutive communication errors of devices occurs. If the numbers presented are constantly above 6 then there is a network problem that slows down the system. If a sensor or mixer has more than 10 communication errors in total, the peripheral device will be deactivated.



More. By tapping this button you will go to More screen, showing more settings.



Password setting. By tapping this button you will go to Password setting screen.



Oil Bypass. In some cases, the heat pump needs to warm up before starting up, and this heating process can take several minutes. Sometimes however, for diagnosis purposes, the heat pump must start without waiting for the oil heating time. To do so, just tap this button. Using this function lightly and without knowledge can lead to compressor damage and to warranty expiration.

4.3.1 Room sensor settings

This screen must be used exclusively by competent personnel and is used to complete the installation of the sensors and related connected devices.

In the section marked with the ROOM name, you can see the following options:

- NAME** **Room name.** Report the name of the room. If no name has been entered then the default name will appear. Touching the name you can edit it.
- INSTALLED** **Installation completed.** By tapping the button to turn it on you will notify the system that the sensor is physically installed and connected.
- ADDED FOR DEW CALCULATION** **Valid for dew calculation.** By tapping the button to turn it on you will notify the system that the sensor will contribute to the system to select the maximum dew temperature (see 4.3.3 More).
- ADDRESS** **Modbus address of the sensor.** By touching the number on the right you can enter an address for the Modbus network to identify this sensor.

In the section named FANCOIL you can see the following options:

- INSTALLED** **Fancoil installed.** Touching the button to turn it on will notify the system that in the room where the sensor is installed, a fan coil has also been installed.
- NO TEMPLARI** **Fancoil not Templari.** Touching the button to turn it on will notify the system that that fancoil is not provided by Templari, so some features may not be available.
- ADDRESS** **Modbus address of the fancoil.** By touching the number on the right you can enter an address for the Modbus network to identify this fancoil.

- RELE' 1 2 3 4** **Relay correspondence.** Each FLOOR board has 8 relay outputs. When the sensor will request, it will inform the system to turn on the relays selected in this table, divided between heating and cooling. If a FLOOR card is not installed, then its relays will not be visible in this table. If a sensor is already connected to a relay, the other sensors will not see it and therefore will not be selectable.

FLOOR 1 FLOOR 2 FLOOR 3

No relay. Touching the button to turn it on will notify the system that this sensor, if requested, will not turn on any relays, but will only inform the relevant FLOOR card that there is a request and mix the water to reach the selected temperature.

4.3.2 Set address

This screen should only be used by competent personnel and is used to modify values in the registers of devices connected to the HCC panel.

DEVICE ADDRESS

Device address. This section of the screen is used to set addresses of new devices.

WARNING!

This procedure does not apply to ROOM sensors.

To change the address of virgin peripherals, they must be connected **one at a time**, and after setting the address, they must be turned off and turn on for after a period of at least 15 seconds.

If the device is installed and connected properly then the default address will appear in the gray box. You can now enter a new address in the black box and then tap the Set button to set the new address to the device. If the assignment is successful, the address in the gray box will be updated to the new value while the value in the black box will return to 0. If this is not the case, then there is probably a network problem. To have the new address become active, the device must be restarted.

Heat pump address: integer. This portion of the screen is used to change an integer register inside a connected Templari heat pump. In the upper box, enter the address to be edited, and the new integer value in the lower one.

Heat pump address: boolean. This portion of the screen is used to change a boolean register inside a connected Templari heat pump. In the upper box, the address to be changed is entered, while the new value in the lower one: lit on means ON, lit off means OFF.

4.3.3 More

This screen is password protected and only qualified personnel should access it. It is used to modify more specific settings.



Thermal source management. With this button you can decide which device will be used to generate heat:



not handled. The thermal source is not known, so you can only set the winter or summer function.



Templari heat pump. All features are available.



thermo-fireplace. Through a 0-10 board it is possible to drive in a limited way the work of the thermal source, producing only heating.



boiler. Through a 0-10 board it is possible to drive in a limited way the work of the thermal source, producing only heating.



modulating pump. Through a 0-10 board it is possible to drive, even if in a limited way, the work of the thermal source.



demo. Used exclusively for demonstrations.



Enable environment management. Use this button to enable or disable the Environments tab. When the Environment tab is not active, all installed ROOM sensors are no longer considered and if the compressor is house request controlled (see below), this is deactivated.

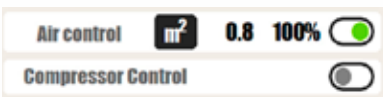

Compressor controlled from house request. This function is divided into two parts.

- **Air controlling:** by activating this function, the individual sensors alert the system of their relevance based on the ambient temperature and how far it is from the setted set point.



Square meters. Use this button to enter the Square meters assignment screen.



Modulating. When the water temperature produced by the heat pump is near the setted limit, the percentage request passed to the heat pump begins to decrease until it reaches 0% when the water reaches the limit value. This number indicates from how many degrees away from the limit the system will begin to reduce the percentage request.



Request limit. This value indicates how much the percentage request is used. Therefore, if the demand is 100% but the limit is 75%, the compressor will only work at 75%. This is useful if you are working with an over-sized heat pump.



On/Off. This button activate and deactivate the function.

- **Compressor controlling:** by activating this function, the Templari heat pump compressor rpm will be controlled by the HCC panel according to the environments request. The higher the demand, the greater the compressor rpm.



I/O board compressor control. This function is alternative to the compressor controlled from house request.

By activating this function, you can command the compressor rpm directly from the analog inputs of the first FLOOR board. You can use 0-10 Volt or 4-20 mA input.



Minimum outlet temperature. When the heat pump works in cooling mode, if there are no devices to dry the environment, the minimum temperature reached should not exceed the dew point to prevent moisture condensing.



Arbitrary value. By activating this button, the HCC Touch panel will use an arbitrary value as the limit, which will however be among the security values. These security values can be shifted by the home temperature and can then move the arbitrary value set by the user.

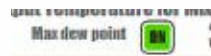

Maximum dew point. By activating this button, the HCC Touch panel will use the maximum dewpoint readed by the ROOM sensors as the limit. If there are no ROOM sensors, you must use the arbitrary value.

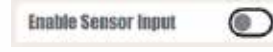

Enable sensor keypad. With this button, you can enable or disable the setpoint change from the ROOM sensor keys.



Restart time. If a blackout occurs, the HCC Touch panel may restart more quickly than the heat pump, and errors may occur in this case. To prevent this, you can set a waiting time to restart in case of blackout.

The number indicates the seconds to wait and ranges from a minimum of 10 to a maximum of 300 seconds. The button activates or deactivates this function.



Service. By tapping this button you will see the Service settings screen.

4.3.3.1 Square meters assignment

In this screen you enter the extensions in square meters of the environments connected to the used ROOM sensors. The more an environment is extended, the more its demand will be important in calculating the final percentage request to be transmitted to the heat pump. Extensions are simply references and do not need to be truthful, sometimes it may be useful to assign different sizes when an environment needs particular heat dissipation requirements.



4.3.3.2 Service settings

This screen must be completed by the installer to enter all his contacts. In this way, the end user will always have a way to contact him in case of assistance.

4.3.4 Set password

This screen should only be used by competent personnel and is used to modify access passwords to Basic and Advanced Settings screens.

4.4 Alarm

In this screen you can see the list of possible panel communication alerts with connected devices.

Whenever one of these alarms appears, the notification is shown in red in the list, indicating also the day and time and the number of times it occurred. If the panel works correctly this list will always be empty, but alarms may appear without this being a problem. Communication alarms can be presented for a variety of reasons and to meet this there is a tolerance of consecutive alarms from the same device before the panel decides that it is not an alarm but an error. If a device collects more than 10 consecutive alarms (see Error Rate Count in 4.3) then the HCC panel will assume that it is malfunctioning and then disconnected to avoid damaging the system by working with potentially incorrect values. In the list then the alert notification will appear in red. At the top right of the monitor, instead of the external temperature, a red triangle will appear to inform the user that an error has occurred. Touching this red triangle will immediately open the alarm screen.

If the user feels that the error is a false positive, or has resolved the problem and wants to reconnect the disconnected device, it can do so by tapping the error line. The writing will return green and the panel will reconnect the device and resume working with it.

Another way to reconnect a disconnected device is through the Advanced screen (see 4.3 Advanced).

Once an error has been notified, the same error will no longer be notified before touching the red line and returning green.

As long as there is a mistake in the list, they will not be notified a second time, even when the same conditions have arisen. Only if the error is cleared will it be possible to receive a new notification.

The heat pump will never be disconnected from the panel, even

when there are errors.

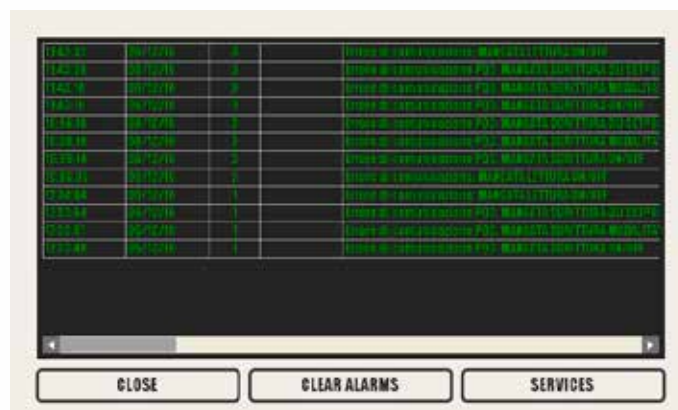

Clear alarms. By tapping this button all alarms will be cleared. This means that a red error becomes a green alarm, and the red triangle in the top right of the main menu disappears, if present. Disconnected peripherals are not reconnected using this function.

5 SCHEDULING

In this section you can observe and set weekly scheduling for the operation of the system.

5.1 Scheduling

By the 7 tabs dedicated to the individual days of the week, you can set the weekly scheduling of the system to select which profile to activate at a specific time of a given day.

When the system works in manual profile, the user selects by his own the various setpoints for heat pump and environments, and these remain valid until they are changed or the scheduling will be reactivated. When the scheduling is active, the user cannot change the current profile because it is decided by the system based on the time zone and the parameters inserted in these screens. **The only way to change the current profile is by changing the scheduling.**

Within each day tab there is a time index that covers 24 hours a day, divided into half-hour blocks, for a total of 48 blocks. Touching the desired block repeatedly changes its color, so you can set whether the ECO (green), DAY (yellow) or NIGHT (blue) profile or none is active during that time. When the block is black, no profile is set and the system is not off, but works to consume the minimum possible.

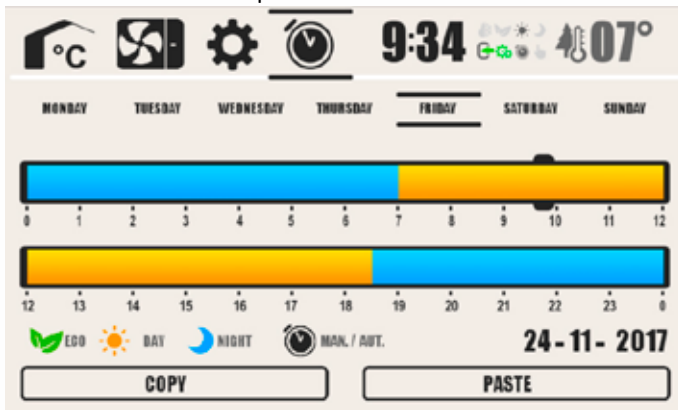

Scheduling. The clock icon indicates that the schedule set in the day time zone is active, while the hand indicates that the system is working in manual profile. By tapping the icon you can switch from one function to another.



Current profile. This indicator shows what half-hour block is currently used by scheduling.



Copiy. It stores a copy of the currently visible day schedule.



Paste. It takes the schedule copy in memory and duplicates it in the day that is currently visible.

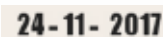

Current date. Touching it will display a numeric keypad and you can set a new date.

6 ADVANCED USE OF THE PANEL

The HCC panel has some advanced features available to installers. All the information below is intended for exclusive use by competent personnel. Any improper use will cause the warranty to be decayed.

6.1 Access advanced features of the HCC panel

Access to the advanced features of the HCC panel requires access to the APPRIATE menu. To do this, access the panel settings through the INSTALLER (4.4) screen.

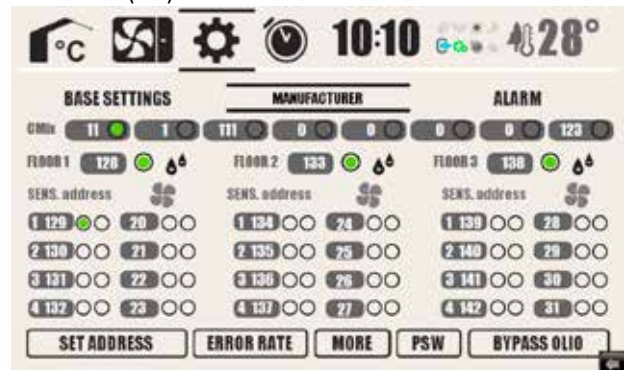

There is an arrow in the bottom right corner. Touching it will open a small menu of panel settings.



Touching the gear icon to the left will open a screen where a password is required.



Type 111111. The dialog box for the Advanced Features of the HCC Panel will open.



6.2 Set a fixed IP address

In some cases it may be necessary to connect the panel to a router using a fixed address. In these cases proceed as follows. In the advanced functions of the HCC panel (6.1), use the Prev and Next buttons at the bottom left to move Tab Network.



In this tab select "IP address get from below" so you can use a fixed IP address.

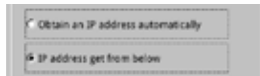

After this you can enter a fixed address. Tap the OK button to confirm the change.

After this you will have to set up your router to make this address accessible remotely. This address will be used for remote viewing via VNC (6.4)

6.3 Change the password for remote access.

In the advanced functions screen of the HCC panel (5.1), use the Prev and Next buttons at the bottom left to move the Tab VNC server setting.



In this tab tap the **VNC login password** button to open the password change dialog box.



In this window, you can set up a remote connection password that will be required each time you connect to a VNC program (6.1).

6.4 Remote vision of the HCC panel

Once the system is completed and the HCC panel is installed, it will be possible to monitor its functions remotely. Steps to make this possible are few and simple.

- Make sure that the HCC panel is connected to the Internet via the appropriate cable.
- Download a Remote Desktop Viewer (VNC) software. Any desktops remote viewing software can go and there are many, both for computers and mobile devices, however we recommend bVNC Free as it is free and has many useful features.
- Retrieve the address to use to connect the viewer to the panel (6.2)
- Start the VNC program you downloaded and when asked enter the address.

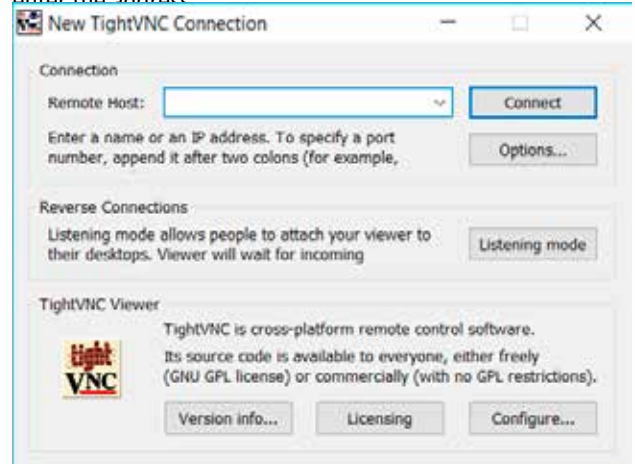

If necessary you will also need to enter a password (5.3).



- Your remote connection will start immediately.

A series of horizontal dashed lines for writing, spanning the width of the page.

A series of horizontal dashed lines for writing, spanning the width of the page.



via Pitagora, 20A - 35030 Rubano (PD) - Italia
Tel. +39 049 5225929 - +39 049 8597400 - Fax +39 049 8055626
www.templari.com info@templari.com



How to install
Easy Access+VNC
APP



How to connect
K-touch display to
the heat pump



Video guide
K-Touch